

3M Industrial Adhesives and Tapes

Types of Stress, Surface Energy, Surface Preparation and Application		03 – 04
High-Strength Bonding Tapes	3M™ VHB™ Tapes	05 – 06
Reclosable Fastening Solutions	3M™ Dual Lock™ Reclosable Fasteners	07 – 08
Lightweight Bonding	3M™ Double Coated Tapes	09 – 10
Structural Bonding	3M™ Scotch-Weld™ Structural Adhesives	11 – 12
Large Surface Bonding	3M™ Spray Adhesives and Cleaners	13 – 14
Fast Strength Bonding	3M™ Hot Melt Adhesives	15 – 16
Lane Marking & Hazard Warning	3M™ Vinyl Tapes	17 – 18
Surface Protection	3M™ Specialty Single Coated Tapes	19 – 20
Bundling, reinforcing, palletising, strapping	3M™ Filament High Strength Tapes	21 – 22
Maintenance, Repairs & Sealing	3M™ Cloth, Duct and Extreme Sealing Tapes	23 – 24
Painting	3M™ Masking Tapes	25 – 26
Carton and box sealing	3M™ Box Sealing Tapes	27 – 28
Short-length Roll Blister Pack Program	3M™ Best sellers for bonding, fastening and sealing solutions	29 – 30

3M Industrial Adhesives and Tapes

Types of Stress

Preferred Design

With tensile and shear forces, entire bond area contributes to strength

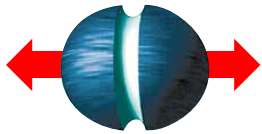

Tensile

Stress acts perpendicular to bond plane

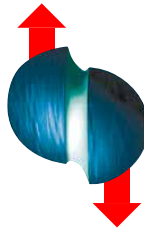

Shear

Stress acts parallel to bond plane

Not Preferred Design

With both cleavage and peel forces, the stresses are concentrated at the leading edge

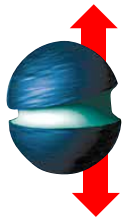

Cleavage

Stress between two rigid substrates

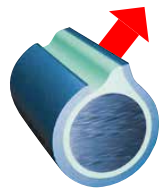

Peel

Stress with at least one flexible substrate

Surface Energy

Choose the right tape for the substrate: Adhesives must flow onto the substrate surfaces in order to achieve intimate contact area

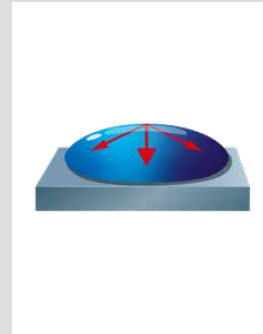

High Surface Energy
Metal, glass

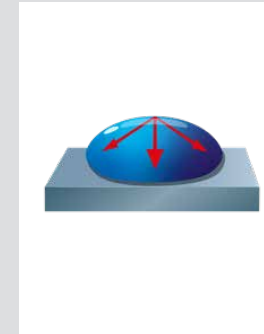

Medium Surface Energy
PET, ABS, PVC (rigid), polycarbonate, polyimide, polyurethane (rigid), acrylic (PMMA), most paints and coatings

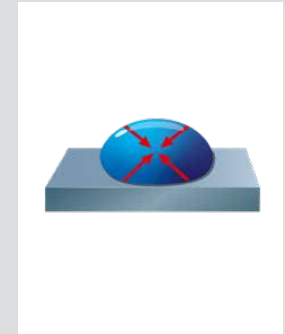

Low Surface Energy
Polypropylene, polyethylene, TPO, PTFE, acetyl, PBT, polystyrene, EPDM rubber, some paints and coatings (PVDF)

Tape Surface Preparation and Application

1. Surface Cleaning

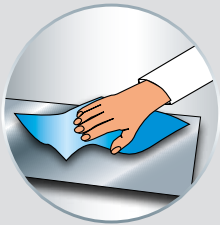

- To obtain optimum adhesion, the bonding surfaces must be well unified, clean and dry
- Wipe surface using an appropriate cleaning agent and a clean cloth
- For glass surfaces use the 3M Silane Glass Primer

2. Application

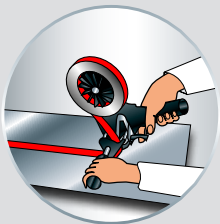

- Apply the tape to the surface. Do not overstretch the tape
- Avoid air pockets
- Do not touch the adhesive or adhesive surface
- Optimum application temperature is between 15°C and 25°C

3. Pressure

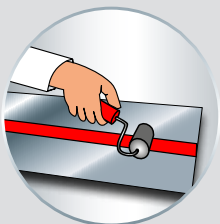

- Bond strength is dependent upon the amount of adhesive-to-surface contact developed
- Firm application pressure develops better adhesive contact and helps improve bond strength

4. Liner Release



- Release the liner in one step (avoid stops)
- Do not touch the adhesive or adhesive surface

5. Joining and Contact Pressure

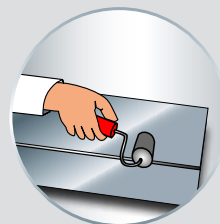

- Apply substrate to the tape
- Avoid air pockets
- Bonding pressure of about 2 kg/cm²

6. Wait for Final Adhesion

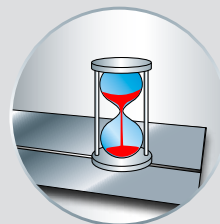

- After application, the bond strength will increase as the adhesive flows onto the surface
- At room temperature, approximately 50% of the ultimate strength will be achieved after 20 minutes, 90% after 24 hours and 100% after 72 hours
- In some cases, bond strength can be increased and ultimate bond strength can be achieved more quickly by exposure of the bond to elevated temperatures (e.g. 66°C for 1 hour)

3M VHB High-Strength Bonding Tapes

With 3M™ VHB™ Tapes, you can maintain consistency from sketch to construction, eliminating distracting, visible fasteners, like screws and bolts. These high-strength, double-sided acrylic foam tapes let you quickly and easily create a long-lasting bond that actually builds strength over time.

A strong, fast and easy way to create durable, reliable bonds.



End User benefits







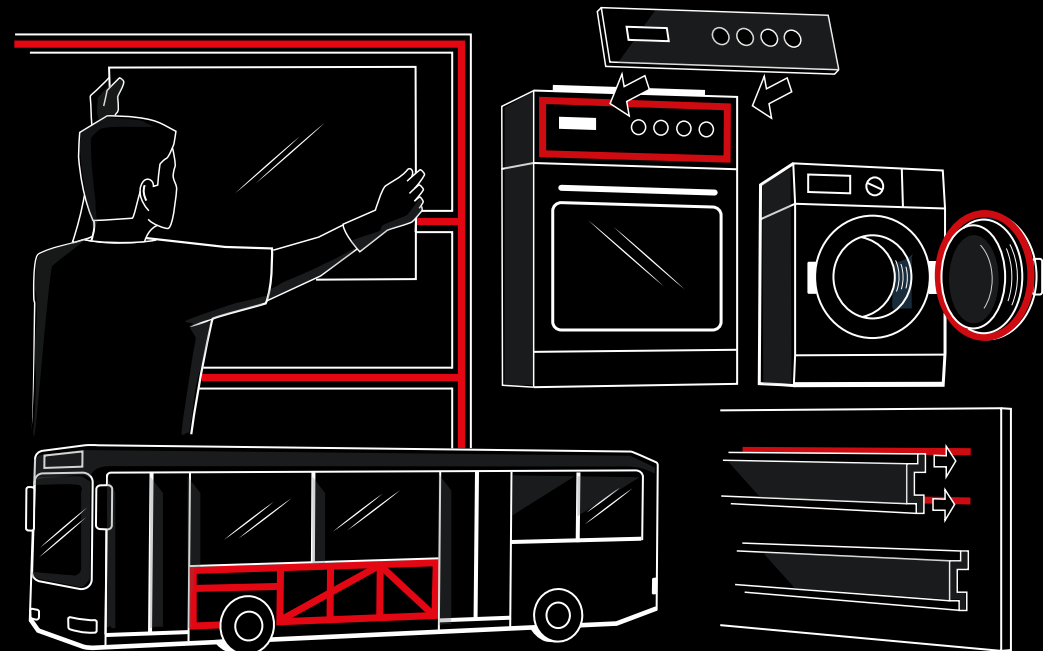



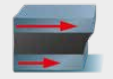

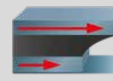
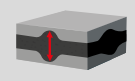

- Invisible bond: Enhance your design appearance with virtually invisible bonding
- Simplifies and speeds up production processes as it provides immediate handling strength and allows to route bonded parts faster through manufacturing operations as no curing time is needed
- Allows the use of thinner, lighter weight and dissimilar materials
- A durable difference: With a bond that's built to withstand the rigours of exposure, 3M™ VHB™ Tapes resist hot, cold and cycling temperatures, UV light, moisture, and solvents.
- Demanding strength: For your most demanding bonding applications, 3M™ VHB™ Tapes distribute dynamic or static stress over the entire surface of the bond, improving holding strength and eliminating the need for mechanical fasteners
- Energy absorption: Stress and energy is absorbed in the foam and not transferred to the bond line
- Stress relaxation: Over time, stress is relaxed away from the bond, and absorbed by the foam core

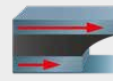
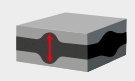
Suggested Applications

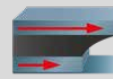
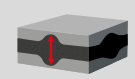
- Bond panel to frame
- Bond stiffener to panel
- Bond of decorative material, trim, attachments
- Bond of nameplates, logos and signs
- Bond electronic displays
- Bond lens window to housing
- Joining transparent material
- Mount backlit translucent signs
- Assembly of components before heat curing paint processing like powder coating or liquid painting

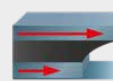
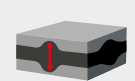



Product	Properties / suitable for	Surface energy			Material expansion / contraction (dilatation max.)	Joint gap tolerances (max.)	Peel strength [Newton/cm] ASTM D-3330	Thickness variations	Key Features
		High	Medium	Low					
 4910	Transparent materials	++	+	-	 2.0 mm	 0.250 mm	 26	4905: 0.5 mm 4910: 1.0 mm 4915: 1.5 mm 4918: 2.0 mm	Designed to create durable and reliable bonds of transparent materials or wherever a clear bond is needed.
 4941	Plasticizer resistant	++	+	-	 3.3 mm	 0.550 mm	 39	4936: 0.6 mm 4941: 1.1 mm 4991: 2.3 mm	Strong and durable bonds to a wide variety of high to medium surface energy substrates like aluminium, stainless steel, galvanised steel, polycarbonate, ABS.
 5952	Powder-coated paints	++	++	-	 3.3 mm	 0.550 mm	 43	5925: 0.6 mm 5952: 1.1 mm 5962: 1.6 mm	Excellent adhesion to the widest variety of surfaces, including most powder coated paints, metals, glass, sealed wood, acrylic, polycarbonate, ABS.
 GPH-110GF	High temperature resistance	++	+	-	 3.3 mm	 0.550 mm	 37	GPH-060GF: 0.6 mm GPH-110GF: 1.1 mm GPH-160GF: 1.6 mm	Excellent temperature resistance when bonding metal parts prior to heat cured paint processing.
 LSE-110WF	PP, TPO, TPE, composite materials	+	++	++	 3.3 mm	 0.550 mm	 44	LSE-060WF: 0.6 mm LSE-110WF: 1.1 mm LSE-160WF: 1.6 mm	Offers a superior bonding performance without primer on difficult to bond substrates such as PP, TPO, TPE, and composite materials.
 3M™ VHB™ Tape Universal Primer UV									Enables strong, durable bonds on surfaces like ABS, PET/PBT blends and other difficult to stick to substrates.
 3M™ VHB™ Tape Primer 94									Promotes adhesion to polyethylene, polypropylene, ABS, PET/PBT blends and other on difficult to stick to substrates.
 VHB™ Surface Cleaner									- Prepares surfaces for bonding - Cleans surfaces to obtain optimum adhesion

Reclosable Fastening Solutions

3M™ Reclosable Fasteners are the easy alternative to traditional fastening methods such as screws, nuts or bolts. Super strength. Ultimate ease. Durable enough to last through repeated opening and closing.

A strong, durable and versatile hold for ultimate ease.



End User benefits







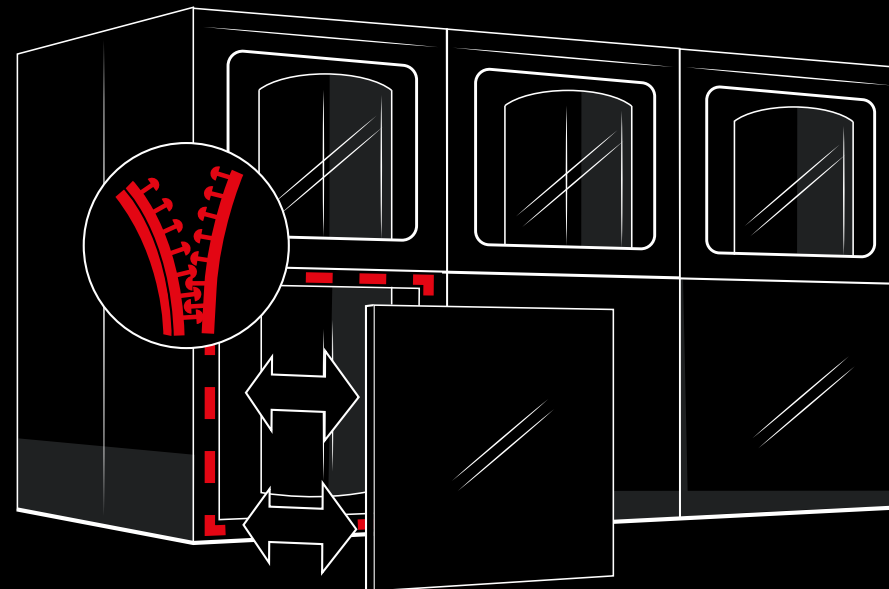

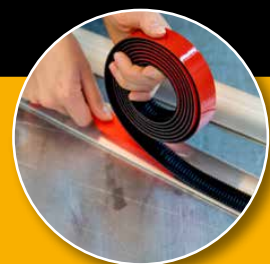

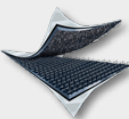
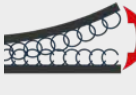
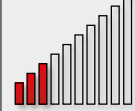

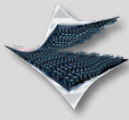
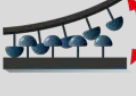
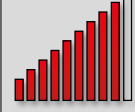

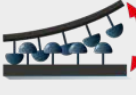
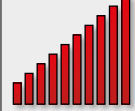

- Super strength: five times the tensile strength of typical hook-and-loop fasteners
- Clean, smooth “behind the scenes” hold for aesthetic improvements – flexibility to fit your designs
- Maintain surface integrity with no holes preventing corrosion or contamination with moisture and dirt
- Simple to apply, use and maintain
- Ability to join dissimilar materials without corrosion and contamination
- Vibration absorption and security, no loosening or failing attachments
- Durable for repeated opening and closings, hundreds of reattachments
- Allows precise alignment before final closure
- Audible click ensuring proper closure
- Reliable performance indoors and outdoors

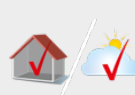
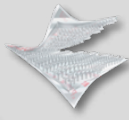
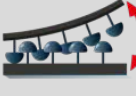
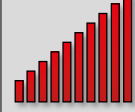
Suggested Applications

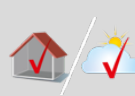
- Panel and cover plate attachment
- Interior signage
- Office partitions
- Graphic attachment
- Access panels
- Specialty vehicles (interior attachments)
- L-bracket edging, repositionable shelving
- Hang signage
- Decorative appliance trim attachment
- Point of purchase display and signage
- Securing fabric to furniture cushions
- Attach cushioning panels

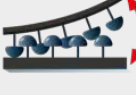
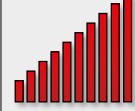

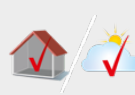
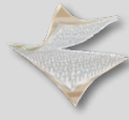
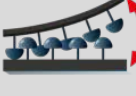
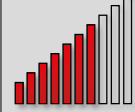

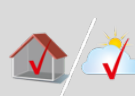
Product	Properties / suitable for	Surface energy			Closure cycle life*	Holding power	Engaged thickness	Indoor and outdoor use	Holding power variations	Key Features
		High	Medium	Low						
 SJ3526 (Hook) SJ3527 (Loop)	Flexible & bendable	++	++	++	 5000		 3.6 mm ± 15%		Outdoor use: – SJ3571 (Hook) – SJ3572 (Loop)	Alternative to a wide variety of reclosable attachment methods, including zips, screws, snaps, hooks and more.
 SJ3540	Polypropylene & polyethylene	++	++	++	 1000		 5.7 mm ± 15%		Stem density (per cm²) – SJ3540: 40 – SJ3541: 62 – SJ3542: 26	Strong, reliable and simple to use reclosable fastener for replacing screws, nails, snaps and rivets. Designed for use for plastics (acrylic, polycarbonate and ABS), powder-coated paints and low-surface energy materials (polypropylene and polyethylene). Indoor use.
 SJ3550-CF	Metals & plastics	++	+	-	 1000		 5.7 mm ± 15%		Stem density (per cm²) – SJ3550CF: 40 – SJ3551CF: 62 – SJ3552CF: 26	Strong, reliable and simple to use reclosable fastener for replacing screws, nails, snaps and rivets. Bonds to a variety of substrates including metals and plastics such as acrylics, polycarbonate and ABS. Indoor and outdoor use.
 SJ3560	Translucent materials	++	+	-	 1000		 5.7 mm ± 15%			Strong, reliable and simple to use reclosable fastener for replacing screws, nails, snaps and rivets. Designed to give a translucent appearance that bonds to a variety of substrates including metals, glass and plastics such as acrylics, polycarbonate and ABS. Indoor and outdoor use.
 SJ3870	Powder-coated paints	++	++	-	 1000		 6.1 mm ± 15%		Stem density (per cm²) – SJ3870: 40 – SJ3871: 62	Strong, reliable and simple to use reclosable fastener for replacing screws, nails, snaps and rivets. Bonds to a variety of substrates including metals, powder-coated paints and plastics such as acrylics, polycarbonate and ABS. Indoor and outdoor use.
 SJ4570	Thin – Low-profile attachment	++	++	+	 150		 2.31 mm ± 15%			Reclosable fastener providing a low profile attachment. Bonds well to a variety of substrates including metals, powder-coated paints and plastics such as acrylics, polycarbonate and ABS. Indoor and outdoor use.

* Number of openings and closings before losing 50% of the original tensile strength

Lightweight Bonding

3M™ Double Coated Tapes, developed for good adhesion on high and low surface energy materials providing excellent initial tack supporting your designs. **3M™ Double Coated Tapes** are engineered with adhesive on both sides of paper, film or tissue. This increases the dimensional stability of the adhesive for easy handling and application.

The power to bond any job, big or small.



End User benefits

- Invisible bond: Enhance your design appearance with virtually invisible bonding
- Simplifies production processes as it provides an immediate handling strength with no curing time
- Faster: Bond long, large and small surfaces. No prep time. No cure time
- Easier: Apply to a variety of surface shapes and forms, or in awkward positions
- Cost-effective: Refillable applicator distributes what you need with no waste
- Cleaner: Consistent thickness with no mess from oozing, glue lines or overspray
- Convenient: Complete multiple jobs without reloading. Tape is easy to break off and liner is removed automatically. No electricity or hoses needed
- Excellent initial tack for enhanced performance as well as high adhesion to a wide range of surfaces

Suggested Applications

- Bonding and mounting of sales displays and billboards
- Fixing and mounting of decorative trims and emblems
- Use for industrial joining and metal fabrication
- Bonding decorative metal trim
- Bonding flexible printed circuits (FPC) to aluminium stiffener or heat sinks
- Bonding mat board in picture frames and dust covers
- Bonding plastic and wood trim for cabinets
- Splicing of paper, films and foils
- General purpose bindery attachment
- Mounting promotional items and posters
- Bonding thin metal panels

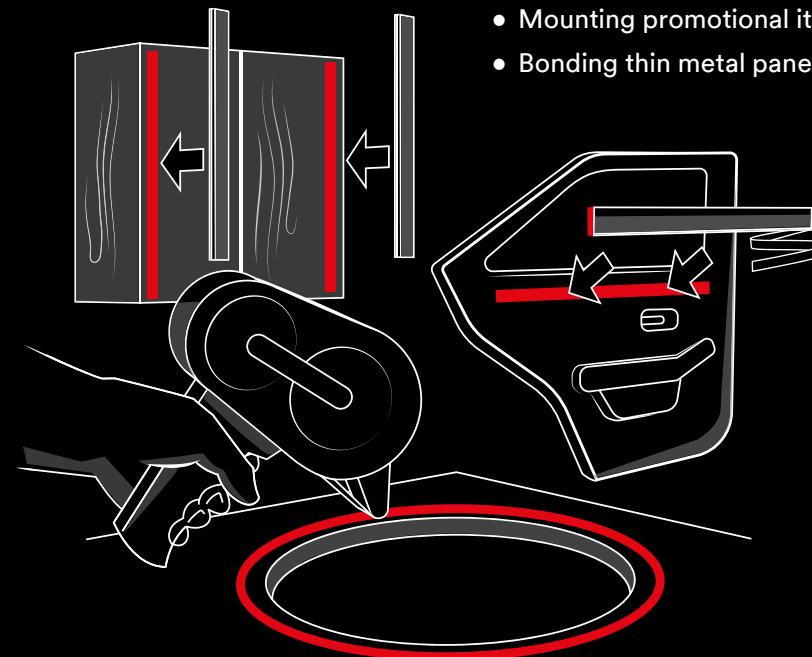



Product	ATG System	Transfer Tape	Properties / suitable for	Bond light-duty applications	Bond heavy-duty applications	Exceptional holding power	Bond temporarily	Very high adhesion & good shear holding power	Excellent resistance to solvents and high temperatures	Indoor and outdoor use	Temperature resistance (min, h)	Peel strength [Newton/cm]	Key Features
		GPT-020	High performance								150 °C – 190 °C	 11.3	High performance tape that combines a high level of peel and shear performance enabling high adhesion to a wide variety of substrates both to high and some low surface energy substrates.
	904		General purpose								70 °C	 5.0	General-purpose solution for light-duty applications. Offers a clean and permanent bond to a variety of materials such as coated and uncoated paper, lightweight fabrics, foils, flexible plastics and foam boards.
	924	465	General purpose								80 °C – 120 °C	 2.7	General-purpose solution for light-duty applications. Offers a clean and permanent bond to a variety of materials such as coated and uncoated paper, lightweight fabrics, foils, flexible plastics and foam boards.
	976	927	High tack, polypropylene & polyethylene								80 °C – 120 °C	 6.6	Designed for bonding materials with glossy coatings where an aggressive adhesive with high initial adhesion and low profile is desired.
	969	950	High tack, polypropylene & polyethylene								80 °C – 120 °C	 8.0	Designed for bonding applications requiring very high initial adhesion and good shear holding power for bonding most plastics, glossy coated materials and varied and textured surfaces. Provides good solvent and UV resistance.
	926	9485PC	High performance and temperature resistance								150 °C – 230 °C	 16.3	Ideal for applications requiring high-bond strength and high-temperature performance. Bonds on contact to a variety of metals, and plastics such as ABS, acrylic, PP, PE, polycarbonate, polyester (PET), nylon and more.
	928	9415PC	Repositionable								50 °C – 80 °C	 0.3 / 1.3	Designed for reusable, or reclosable applications which allows removal from many papers, foils, and films.
		9473PC	Very high performance and temperature resistance								150 °C – 260 °C	 14.2	High performance tape designed for applications requiring very high shear holding power and bond strength ideally suited to industrial joining and metal fabrication.
	ATG 700 Adhesive Applicator												A lightweight, portable, one-hand solution for applying adhesive transfer tape in a quick, easy, single-handed operation.

Structural Bonding

3M™ Structural Adhesives. Engineered for strength, design innovation and multi-material assembly. Our Structural Adhesives provide the strength you need while enabling lightweight, high-performance designs and new production realities.

Durable holding power for even the most challenging applications.



End User benefits

- Improve aesthetics: invisible joints, replace rivets, welds and screws, create smoother bond lines
- Lightweighting: eliminate the weight of mechanical fasteners, use thinner, lighter materials
- Freedom to design: bond multiple materials, smaller joints take up less space
- Cost-efficient: use thinner materials to decrease costs, eliminate post-finishing
- Accurate and easy: control dispensing with 3M™ EPX™ exact proportioning and mixing applicators
- Stronger bonds: eliminate stress peaks
- Non-sag formulation ensures adhesive stays where applied
- Resists many chemicals, water, humidity and corrosion
- Provides a strong, permanent bond with high shear strength and good peel even under vibration and impact combined with good flexibility

Suggested Applications

- General attachment applications in a variety of industries
- Joining plastics to metals, such as in the manufacture or repair of appliances
- Impact resistance composite bonding
- Metalworking such as HVAC, appliance, and specialty vehicles
- Sign manufacturing such as panel to frame bonding, trim attachment, letter bonding, and frame assembly
- Bonding plastics, composites and powder coats to metal
- Typically used where fast assembly of smaller parts is required
- Transportation applications, such as rail and automotive
- Semi-flexible potting compound

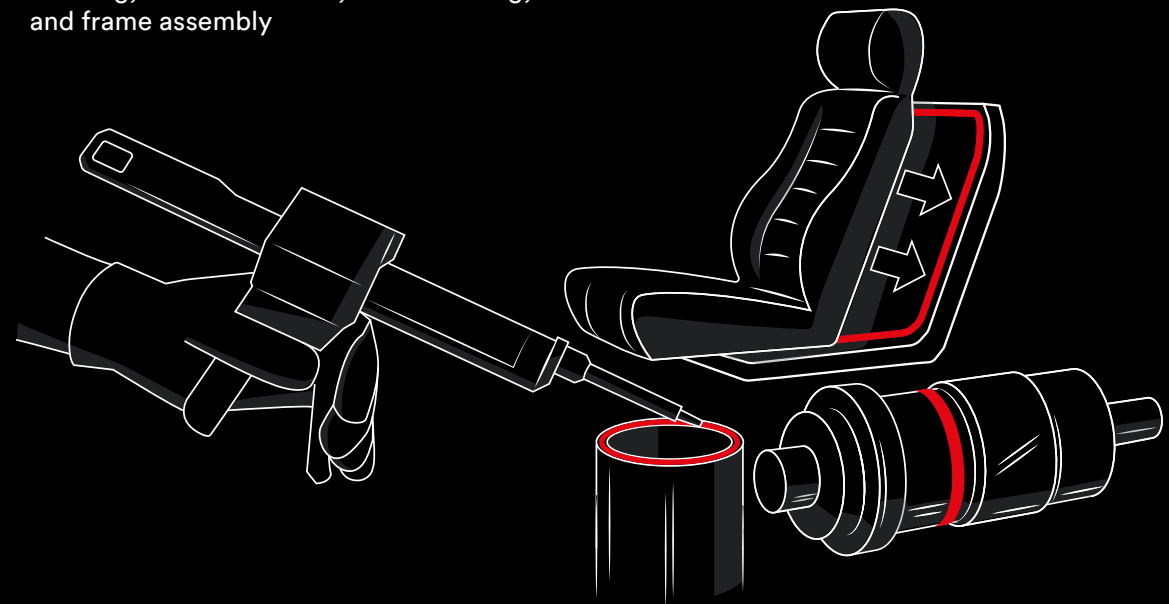



Product	Properties / suitable for	Static and dynamic loads (vibration and impact)	Bonding of materials with different dilatation (thermal expansion)	Bonding of electronic components	Bonding of polypropylene, polyethylene, TPE	Bonding of composite	Fast strength build up	Approx. work life [min]	Surface energy			Base	Key Features
									High	Medium	Low		
DP410	Vibration and impact							12	++	+	-	Toughened Epoxy	Two-part epoxy adhesive with good stability under static and dynamic loads (vibration and impact). Viscoplastic. Shorter work life.
DP460	Vibration and impact							60	++	+	-	Toughened Epoxy	Two-part epoxy adhesive designed for bonding of electronic components. Good stability under static and dynamic loads (vibration and impact). Viscoplastic. Medium work life.
DP490	Vibration and impact					✓		90	++	+	-	Toughened Epoxy	Two-part epoxy adhesive with good stability under static and dynamic loads (vibration and impact). Viscoplastic. Longer work life.
DP8405NS	High-impact adhesion to most plastics						✓	4-6	++	++	-	MMA Acrylic	Viscoplastic two-part acrylic adhesive with good stability under static and dynamic loads (vibration and impact). Very fast rate of strength build. Very short work life.
DP8407NS	High-impact adhesion to most metals						✓	7	++	++	-	MMA Acrylic	Viscoplastic two-part acrylic adhesive with good stability under static and dynamic loads (vibration and impact). Bonds to a variety of substrates (especially bare metals) while resisting corrosion.
DP8005	Bonds PP and PE						✓	2-3	++	++	++	Low Surface Energy Acrylic	Elastic two-part epoxy adhesive designed for bonding of low surface energy substrates (e.g. polypropylene, polyethylene, TPE – Thermoplastic Elastomers). Very short work life.
DP100Plus	Multi-purpose adhesive						✓	4	++	+	-	Flexible Epoxy	Very flexible, fastsetting, two-part epoxy adhesive that cures clear. 4 minutes worklife.
DP110	General purpose flexible bonds					✓		8	++	+	-	Flexible Epoxy	Flexible, fast-setting, two-part epoxy adhesive that provides a strong, permanent bond even under vibration and impact.
DP125	General purpose flexible bonds							25	++	+	-	Flexible Epoxy	Flexible two-part epoxy adhesive that creates strong structural vibration resistance bonds on metal, ceramics, wood and many plastics.
DP190	High flexibility and elongation							90	++	+	-	Flexible Epoxy	Two-part epoxy adhesive that features high flexibility and elongation and provides tough, strong bonds through high shear and peel strength. Longer worklife.
DP8610NS	High flexibility and low odour						✓	10	++	+	-	MMA Acrylic	This unique structural strength adhesive combines the fast cure and minimal surface preparation of an acrylic with the high flexibility and elongation commonly found in urethanes or sealants.
DP8710NS	Enhanced impact and peel strength						✓	10	++	+	-	MMA Acrylic	It maintains the convenience of acrylic adhesives with fast curing and minimal surface preparation, while delivering improved impact strength, cold temperature resistance, flexibility and toxicological hazard profile.
DP609	Especially for plastics and wood							9	++	+	-	Flexible Polyurethane	Flexible two-part urethane adhesive designed for good stability under static and dynamic loads (vibration and impact). Especially for plastics and wood. Shorter work life.
DP6310NS	Bond most composites					✓		9	++	++	-	Flexible Polyurethane	Semi-rigid polyurethane designed to bond most composites and dissimilar substrates.

Large Surface Bonding

At the touch of a finger – bonding power for substrates from paper to metal. 3M's portfolio of industrial-grade spray adhesives is designed to make assembly fast, convenient and efficient.

Bonding power for substrates from paper to metal – at the touch of a finger.



End User benefits







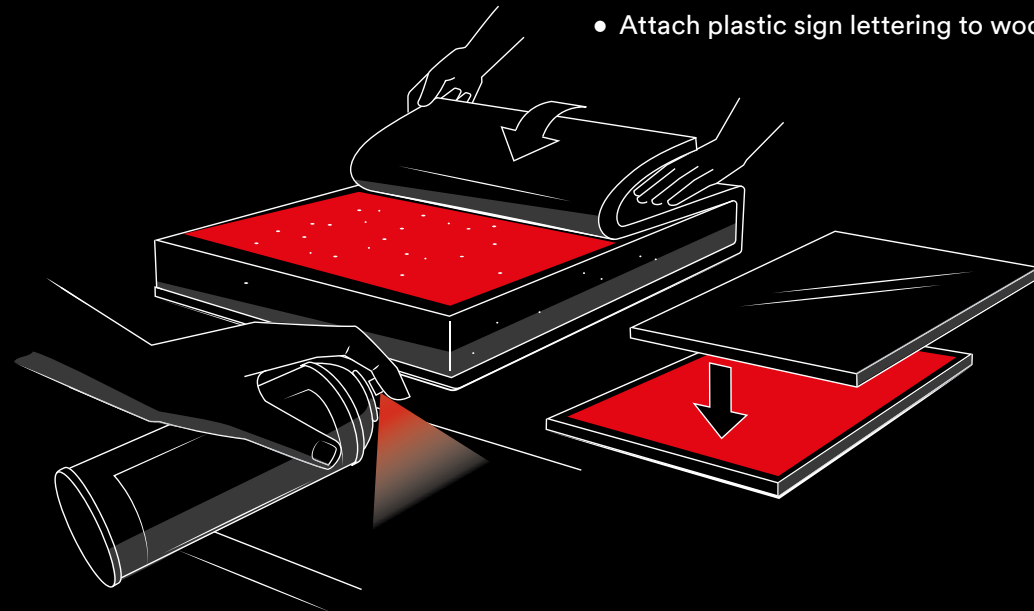



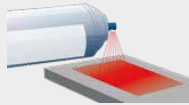



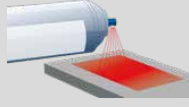



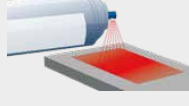



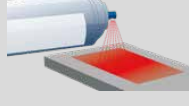

- At the touch of a finger – bonding power for substrates from paper to metal
- Low soak-in property, giving you time to find the best fit for your parts
- Soft, non-dimpling bond lines
- Aggressive tack that offers a high initial grab as well as sufficient open time to position materials properly
- Variable-width lace spray pattern to minimise waste and overspray
- Aggressive tack that offers a high initial grab with foam-tearing strength, yet allows sufficient open time to position materials properly
- Versatile adhesive that bonds a wide range of lightweight materials such as fibreglass, foam, polystyrene, paper, felt, wood, plastic and more
- Fast drying, easy to dispense, transparent high strength spray adhesive that bonds on concrete, wood, MDF, laminates, polyethylene, polypropylene SBR rubber and more

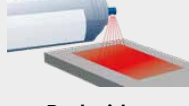
Suggested Applications

- General upholstery and flexible foams bonding (e.g. PU or latex)
- Foam lamination. Attaching foam and fabric to wood and other substrates
- Bond insulating material such as polystyrene, rock wool, glass wool
- Attaching fibreglass insulation and drywall corner beads
- Bond thin decorative film, foils, and fabrics
- For variety of display and furniture jobs
- Picture framing and mounting displays
- Adhere polyethylene, polypropylene to wood, metal and more
- Bond decorative laminate to tables, cabinets and shelving
- Attaching fibreglass insulation and drywall corner beads
- Bond kick plates to office desks
- Attach plastic sign lettering to wood

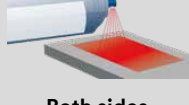

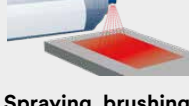

Product	Properties / suitable for	Spray adhesive application	Spray pattern	Bonding range	Dry time	Key Features
 Spray 74	Foam & fabric	 Both sides	 Variable lace	 Up to 10 min	 15 – 30 sec	Extremely fast tacking adhesive with immediate foam-tearing strength and soft, non-dimpling bond lines that bonds fabrics, foam and upholstery to a variety of substrates and themselves.
 Spray 75	Repositionable & removable	 One side	 Mist	 Permanently tacky	 15 – 60 sec	Repositionable spray adhesive that's ideal for hold and position of many lightweight materials.
 Spray 76	Hi-tack	 One side or both sides	 Variable lace	 Up to 60 min	 1 – 2 min	High-tack spray adhesive that creates effective, strong bonds for many hard-to-hold materials, such as polyethylene and polypropylene.
 Spray 77	Multi purpose	 One side or both sides	 Mist	 Up to 15 min	 15 – 60 sec	Multipurpose adhesive with a fast, aggressive tack suitable for a wide range of applications, bonding lightweight materials such as fibreglass, foam, paper, felt, wood, plastic and more.
 Spray 80	Rubber & vinyl	 Both sides	 Variable lace	 Up to 15 min	 1 – 3 min	High-performance, high strength adhesive designed for bonding rubber and vinyl sheets, including weather stripping.
 Spray 90	Heavy duty & hi-strength	 Both sides	 Variable lace	 Up to 10 min	 Up to 1 min	A versatile, high-temperature resistant, fast-drying adhesive that forms extremely strong bonds on a wide range of materials such as metals, wood, HPL, rubber, carpet and flooring.
 Industrial Cleaner	Maintenance & cleaning	 Spraying, brushing				The citrus based cleaner can help to prepare surfaces for adhesive bonding and removes dirt, grease, tar and various non-curing adhesives.

Fast Strength Bonding

3M™ Hot Melt Adhesives. Superior Bonding. Superior Speed. Improve productivity and aesthetics while lowering costs and minimizing waste with the 3M™ Hot Melt Adhesive System, an environmentally friendly and virtually odourless bonding solution.

Superior
bonding.
Superior
speed.



End User benefits







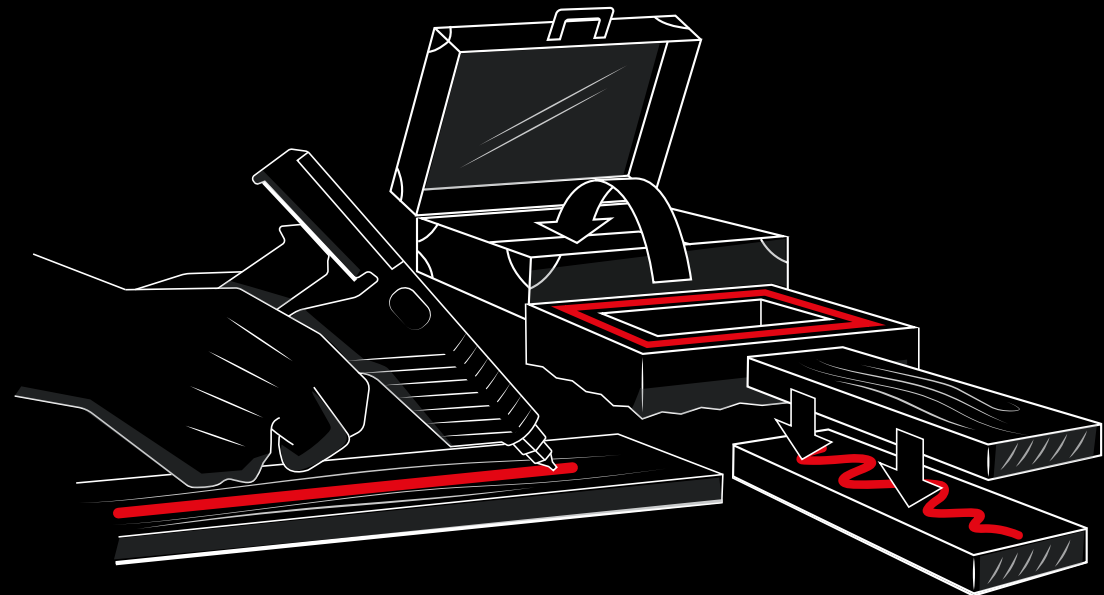



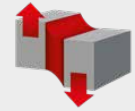

- Improve your production speed and ease: you can move assemblies immediately and eliminate clamps, fixturing, and drying time and energy
- Improve appearance: hot melt adhesive is virtually invisible between the mating surfaces
- Low melt adhesives are available for lower operating temperatures and bonding heat sensitive surfaces
- Excellent “hot tack”, fast setting for corrugated, beadboard, recoupage, repacking chipboard and wood
- Excellent impact resistance and good shear and peel strength
- Fast, durable product performance for small joint, mounting and trim attachment, large surface lamination and more
- Open bond time allows for fit adjustment and positioning
- Outstanding electrical properties and non-corrosive to copper make it an ideal solution for electrical applications
- High delivery rate and long bonding range

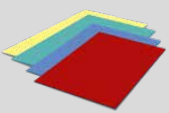
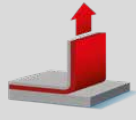
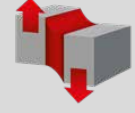
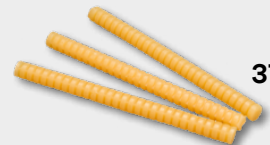
Suggested Applications

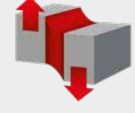
- Electronic applications such as potting and wire tacking, and bonding
- Transportation interiors
- Seating attachment
- Manual and corrugated carton sealing
- Repacking chipboard
- Point-of-purchase displays
- Trade exhibits
- Mounting and trim attachment
- Assembly, attaching, repairing, potting, panel bonding, wire tacking, bundling, sealing, encapsulating
- Panel bonding
- Woodworking and furniture manufacturing
- Upholstery

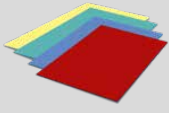
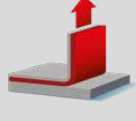
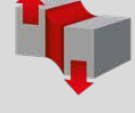

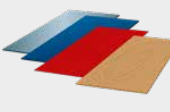

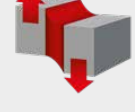
Product	Wood	Electronics	Cardboard	Plastics	Universal	Peel strength [Newton/cm]	Shear strength [MPa]	Key Features
 3738						 23	 2.6	Designed for woodworking and general industrial applications. Low temperature of application makes work safer and allow to work with materials which is sensitive to high temperature such as polystyrene foam, thin plastics and etc.
 3748						 32	 2.2	Designed for electronic applications: large surface lamination, sealing, potting and encapsulating. Especially for low surface energy plastics and coatings such as polyolefins. Good high temperature stability and thermal shock resistance.
 3762						 12	 3.8	Designed for packaging and corrugated carton sealing: small joint assembly. "Quick grab" for instant adhesion.
 3764						 25	 2.7	Excellent general plastics bonder with low temperature flexibility.
 3792						 23	 1.7	Clear, multipurpose hot melt adhesive for wood, fabric, upholstery, and other lightweight materials. Low temperature of application makes work safer and allow to work with materials which is sensitive to high temperature such as polystyrene foam, thin plastics and etc.

Lane Marking & Hazard Warning

A tape for every job. Whether you're marking a wall, a pipe, or a loading dock, 3M has the right product durability, flexibility and vibrant color you need to help maximize your workflow, safety and factory or warehouse appearance.

Tough jobs
call for even
tougher tapes.



End User benefits







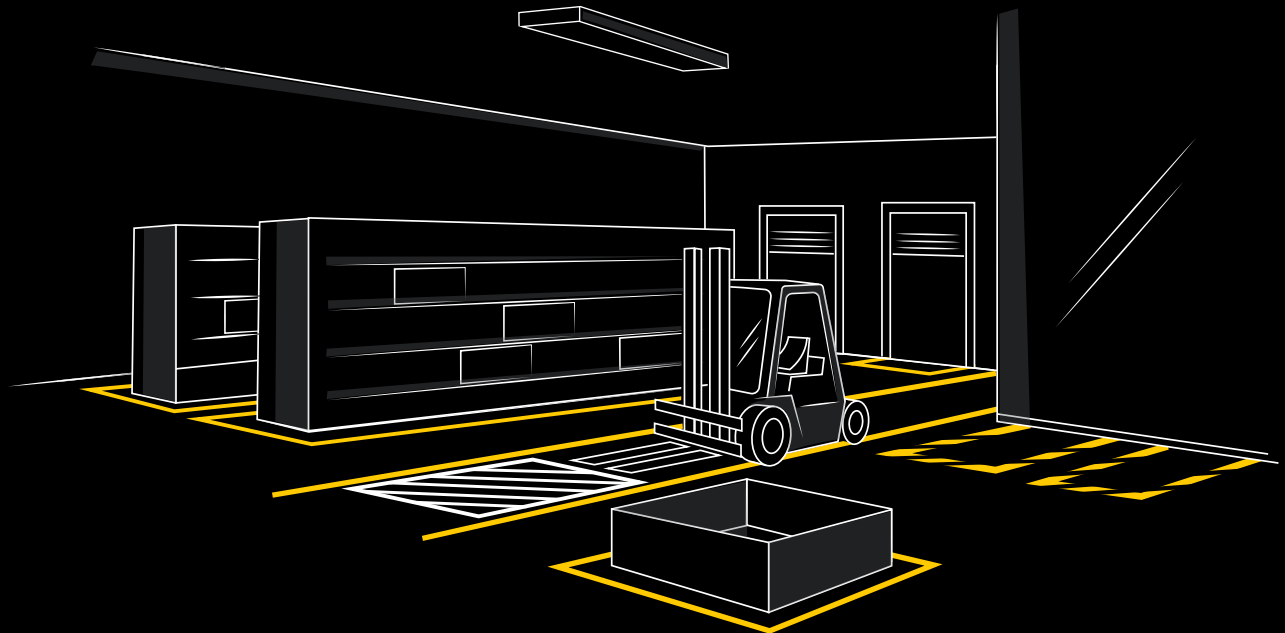













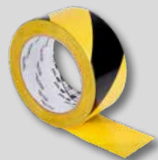

- Unlike paint solutions, the marking tape is installed quickly and can be removed and cleaned up easily without damaging the respective surface
- Easy to apply, tape stretches around corners for a reliable tight fit
- The adhesive provides a strong bond to most floors and excellent holding power
- Conformable backing makes vinyl tape ideal for use on curved and irregular surfaces
- One-piece clean removal from many surfaces, lower clean up costs
- Colour is integral to tape construction for long-term high visibility and abrasion resistance
- Unique stretch properties enable tape to remain stretched to conform to uneven surfaces without lifting and retracting
- Bright colours for high visibility
- Available in a wide variety of colours and sizes for diverse applications

Suggested Applications

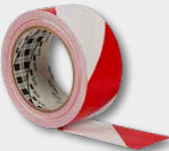
- Lane and safety marking
- Marking of equipment pitch points or gears for warning purposes
- Colour code piping, tools, instruments, etc.
- Protect parts, equipment or products from abrasion
- For taping, wrapping or sealing many curved or convex surfaces
- Floor marking in high traffic areas (pallets and heavy equipment)
- General purpose holding and bundling
- Marking of parts or machines
- Lane and safety marking applications
- Helps identify hazard areas

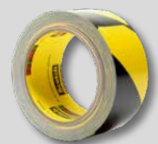

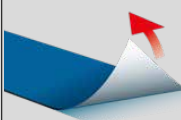

Product	Properties / suitable for	Colour marking	Floor, wall, or loading dock marking	Hazard area marking	Clean removal	Traffic areas	Key Features
 471	Long-term high visibility						Strength, bright and long-lasting colours, conformability, instant adhesion and long-term clean removal make 3M™ Vinyl Tape an exceptional choice for floor and safety marking applications.
 971	Superior durability						Designed for long-term floor marking and engineered for heavy traffic and tough conditions such as scuffing from pallets and heavy equipment.
 764	Economical lane and colour marking						When you're not dealing with tough conditions or the need for a long-term clean removal, this general purpose vinyl tape is a cost-effective choice for a variety of hazard, safety marking, and colour coding applications.
 766	Economical safety marking						General purpose striped vinyl tapes in black and yellow ideal for marking of equipment pinch points or gears for warning purposes. It can also be used for floor marking in light traffic areas, and around equipment or spills.
 767	Economical safety marking						General purpose striped vinyl tapes red and white are ideal for marking of equipment pinch points or gears for warning purposes. It can also be used for floor marking in light traffic areas, and around equipment or spills.
 5702	Long-term high visibility						Developed to provide clear safety indication for driving and walking lanes, hazardous areas, protruding equipment and low hanging objects.

Surface Protection

No matter what your taping situation is, there's a 3M Specialty Tape to help you conduct, reflect, protect, seal, mark, quiet and more. Whatever your application, 3M can meet your needs with a tape to get the job done right.

No matter what your taping situation is, there's a 3M™ Specialty Tape to help.

End User benefits







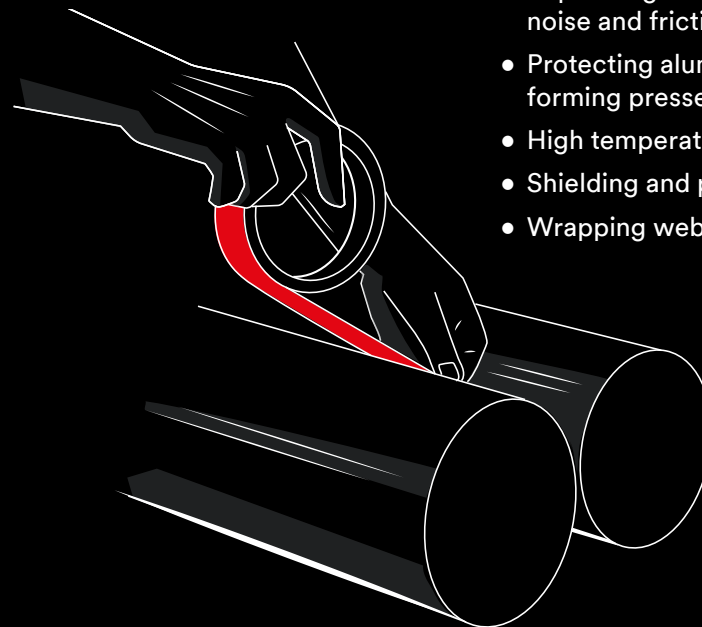





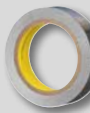

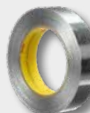

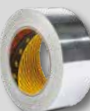

- 3M aluminium foil tape 425 can withstand a variety of moisture, weathering, UV and solvents in order to provide an excellent work life, indoors or out
- The light reflective tape enhances lighting efficiency
- High thermal conductivity enhances heating or cooling efficiency
- Due to its exceptional heat resistance and low moisture absorption, 3M glass cloth tape 361 has a wide operating range and also performs in humid environments with intermittent temperatures
- Strong abrasion resistant backing resists shrinking, rotting or burning, providing exceptional stability in harsh environments
- 3M™ UHMW-PE Film Tape 5423 is often used in general industrial applications to help control squeaks and rattles due to vibration or wear of metal and plastic materials
- PTFE tape can be applied to create an easy release surface on machine parts where build-up of sticky materials and inks occur – perfect for the transportation, electronics or metalworking industries
- Slippery, low energy surface for smoother material movement

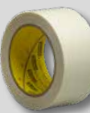
Suggested Applications

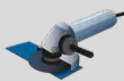
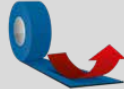
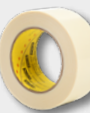
- Heat shielding and heat reflecting of delicate parts
- Masking in chemical paint stripping
- Light reflecting for light enhancement
- Seaming and sealing
- Refrigerator and freezer coil attachment
- Splicing of thin gauge foils
- Permanent sealing of high temperature ducts or chambers
- Use for fabric splicing, seaming and sealing panels
- Reducing squeaks and rattles in automotive and transportation assemblies
- Lining of conveyors, chutes, blades, slides and guide rails
- Separating dissimilar parts to reduce noise and friction
- Protecting aluminium sheets on stretch forming presses
- High temperature wire bundling and harnessing
- Shielding and protecting against chemicals
- Wrapping web rollers to reduce friction

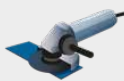
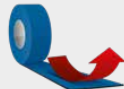

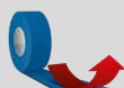

Product	Properties / suitable for	Lead foil tape	Performance aluminium foil tape	General purpose aluminium foil tape	Sealing of high-temperature ducts or chambers	Noise reduction between dissimilar parts	Protection of grinding areas	Low friction & non-stick surface applications	Slippery, low energy surface for smoother material movement	Key Features
 420	Lead foil tape									Electrically and thermally conductive tape. This highly conformable tape is ideal for the electroplating, chrome plating, burnishing and anodising processes.
 431	Performance aluminium foil tape									Designed for heat shielding, heat reflecting, light enhancement, seaming and sealing. Both indoor and outdoor.
 425	Performance aluminium foil tape									Designed for heat shielding, heat reflecting, chemical masking, light enhancement, chemical milling, seaming, sealing and de-paint operations. Both indoor and outdoor.
 1436	General purpose aluminium foil tape									General purpose foil tape ideal for ducting work, sealing and insulation in construction and air conditioning.
 361	Glass cloth tape high temperature resistant									For high temperature applications such as sealing ducts, plasma spray masking and as a back-up strip for submerged arc welding.
 5421	UHMW-PE tape low friction									Designed for applications requiring a low coefficient of friction or a reduction of squeaks, rattles, noise.
 5423	UHMW-PE tape low friction									Designed for applications requiring a low coefficient of friction or a reduction of squeaks, rattles, noise.
 5490	PTFE tape anti-stick									Designed to improve surface movement, eliminate squeaks and rattles, and reduce machine noise.

Bundling, reinforcing, palletising, strapping, heavy box closure

When you need a tape as strong as your reputation, you can count on 3M's consistently reliable, market-leading high strength tapes.

A proven, high strength technology for over 70 years.

End User benefits







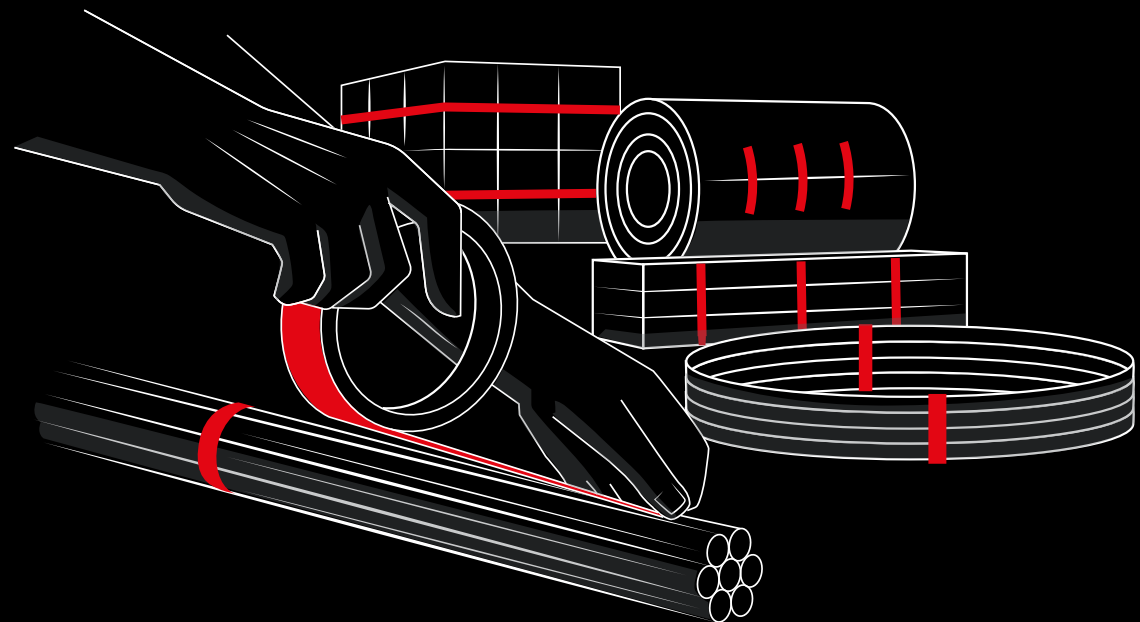





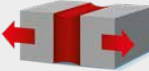
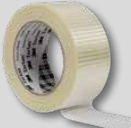





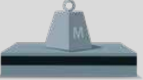

- Bonds easily with high initial adhesion to most corrugated fibreboard substrates
- Brands, bar codes and other graphics can be read through the translucent tape
- Able to withstand rough shipping and handling conditions
- Resists nicks, abrasions, moisture, and scuffing
- Adhesive offers excellent balance of initial adhesion and long-term holding power
- Light-duty high strength filament tape for light-duty bundling, reinforcing and pallet unitising applications
- Bi-directionally fibreglass reinforced tape provides cut and tear resistance in machine direction and cross direction
- High tensile strength ideal for heavy duty strapping, bundling, splicing and reinforcing applications

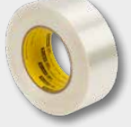
Suggested Applications

- Light-duty strapping, bundling, and reinforcing applications
- Box closing and reinforcing
- Cross web splicing
- Bundling of heavy weight products
- Metal coil tabbing and bundling
- L-clip and U-clip closures
- Pallet unitising, bundling for shipping and handling





Product	Properties / suitable for	Light weight bundling & reinforcing	Medium weight bundling & reinforcing	Heavy weight bundling & reinforcing	Clean removal	Peel strength [Newton/ 25 mm]	Tensile strength [Newton/ 25 mm]	Key Features
 8953	Fibreglass longitudinally reinforced					 13.8	 625	Cost-effective general purpose filament tape used for light-duty strapping, bundling, and reinforcing applications.
 8954	Bi-directional fiberglass reinforced					 17.5	 338	Cost-effective general purpose filament tape used for holding boxes together on pallets, salvaging torn, bundling of light to medium weight products.
 8956	Fibreglass longitudinally reinforced					 20	 650	Universal general purpose filament tape mainly used for holding boxes together on pallets, bundling of lightweight products, closing and reinforcing of fibreboard boxes.
 8959	Bi-directional fiberglass reinforced					 22.5	 700	Universal general purpose high strength filament tape ideal for medium-duty strapping, bundling, splicing, and reinforcing.
 8981	High performance					 19.3	 1665	Heavy-duty performance filament tape ideal for L-clip and U-clip closures, metal coil tabbing and bundling.
 8915	Removable					 17.8	 745	Clean removal filament tape designed to hold appliance parts and other consumer goods in place during manufacturing and shipping.

Maintenance, Repairs & Sealing

Built to stick. Whether your surface is smooth and refined, or rough and rugged; whether your job is for one hour or one year, 3M's portfolio of maintenance, repair & sealing tapes meets the industrial demands for sealing, repairing, bundling, coding or fixing in heavy duty or non-critical applications.

*Built to stick.
Extremely fast,
clean and easy.*



End User benefits

Extreme Sealing Tapes

- Protect and seal with confidence: sticks on contact to many metals and plastics without drying time, dripping, oozing and clean-up
- Conforms over contours, edges, rivets and screw heads for a water tight seal
- Durable sealing that withstands harsh environmental conditions resist UV light, moisture, and solvents for years
- Paintable: you can match most existing colors to blend seamlessly into the surrounding area

Duct & Cloth Tapes

- High instant adhesion – sticks immediately and stays on reliably
- Provides a tight, moisture-resistant seal in many containment situations
- Tears easily by hand, in both directions of the cloth
- Individually wrapped for easy identification and to keep the roll clean until ready for use

Suggested Applications

Extreme Sealing Tapes







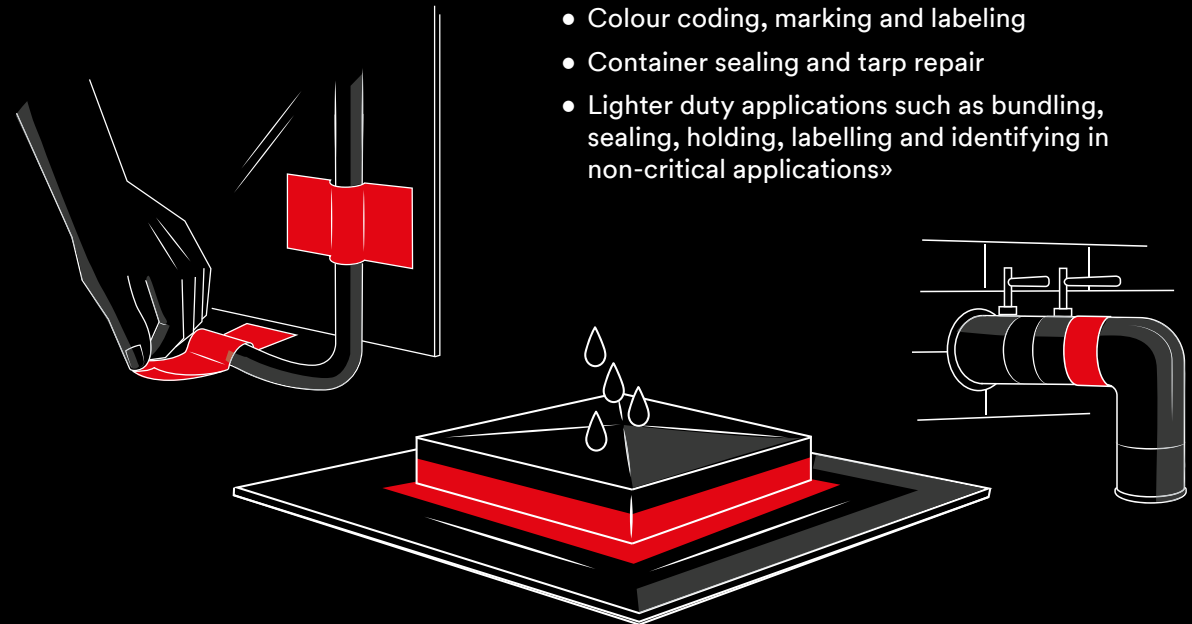



























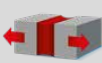













- Use for difficult sealing applications like joints, seams or penetration
- Truck and trailer roof sealing
- Skylights sealing
- Window and door sealing
- «Roof-to-trim» sealing

Duct & Cloth Tapes

- Joining and sealing of sheetings, wallboards, metal and plastic ducting
- Splicing of insulation, pipes and panels (hinge effect)
- Cauling and protection with film splicing for treatment or decontamination
- Wrapping of containers and pipes
- Colour coding, marking and labeling
- Container sealing and tarp repair
- Lighter duty applications such as bundling, sealing, holding, labelling and identifying in non-critical applications»

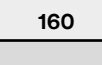

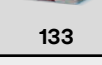

Product	Value duct tape	General purpose	Heavy duty	Extra heavy duty	Clean removal	Vinyl general purpose duct tape	Extreme sealing tape	Indoor and outdoor use	Peel strength [Newton/25 mm]	Tensile strength [Newton/25 mm]	Available in multiple colors	Key Features
 1900									 15	 70	Silver, black	Cost-effective duct tape for utility and general use and lighter duty non-critical applications.
 DT 8									 18.8	 102	Silver, black	DT8 offers high instant adhesion to a variety of surfaces coupled with good conformability, making it an ideal tape for quick repairs, splicing, temporary holding, labeling and light-duty bundling.
 2903									 20	 100	Silver, black	General purpose conformable duct tape for general maintenance, bundling, wrapping, attaching, sealing, and protecting. High tensile strength makes it ideal for bundling. Good adaptability.
 DT 11									 21	 123	Silver, black	DT11 is considered a go-to choice for demanding jobs and is used today in a variety of maintenance, repair and construction settings. This tape allows moisture-resistant seal in many containment situations, such as pipe sealing and attaching heavy poly draping.
 2904									 27.5	 110	Silver, black	Heavy duty duct tape for general maintenance, bundling, wrapping, attaching, sealing, protecting, and colour coding.
 DT 17									 23	 164	Black	This tape is ideal for jobs requiring strength, wear resistance or protection of covered surfaces. Excellent for repairing, seaming, extra-strength bundling and helps in protecting metal parts and surfaces against sandblast overspray.
 389									 22.5	 200	Silver, black, white, red, dark blue, light blue, olive, green	389 provides high instant adhesion and the strong water-resistant backing resists wear and light abrasion. Provides a tight, moisture-resistant seal in many containment situations. Available in many different colours.
 8979									 15.5	 160	Slate blue	Performance plus duct tape designed for clean removal on most opaque surfaces for up to 6 months in many outdoor and indoor applications. Resistant to delamination and deterioration when exposed to UV outdoors for up to one year.
 3903i									 12.5	 133	Silver, black, white, yellow	Vinyl Duct Tape 3903i is a hand-tearable general purpose tape with a rubber adhesive and embossed vinyl backing. Applications in the construction, electrical and industrial markets. Color-coding, non-critical masking, wrapping and bundling.
 4411									 33.5	 54.5	Translucent, grey, black	Professional seal over an existing joint or seam which can be exposed to direct sunlight, as well as temperature and humidity extremes.

Painting

Masking made simple. Now it's easy to choose the best tape to get industrial jobs done right. This simplified 5-tape system is built on increasing levels of performance and the common goal of helping you finish jobs worth finishing.

Temporary holds you can count on.

End User benefits



- Crepe paper backing for conformability that will maintain integrity when formed around corners
- Good instant adhesion and holding power that resists lifting or curling
- Removes cleanly in one piece with no residue from most surfaces
- Backing saturated for easy tear – resists slivering yet hand tearable
- The tape resists solvents and moisture and will not bleed through – also suitable for use with water-based paint systems
- Helps resist paint bleed through to help create good paint lines
- Excellent UV resistance for long term indoor and outdoor use up to 6 weeks
- It offers a sharp paint line
- Ultra-flat paint edges – extremely thin backing material

Suggested Applications

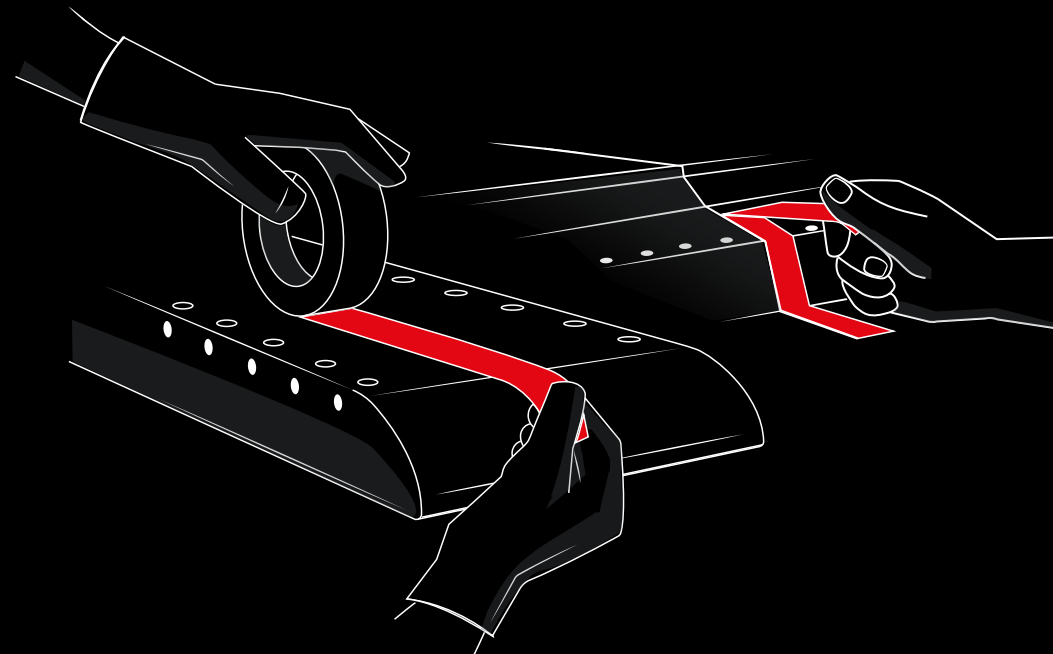
- Outdoor painting and varnishing work
- Paint masking applications in the building construction market
- Painting in the metal construction market, particularly on delicate surfaces
- Masking for joint sealing applications
- General-purpose industrial paint masking
- Air drying and oven curing of paint and lacquer
- Oven-drying systems, infrared or heat lamps
- Suitable for infrared/UV-curing and bake cycles
- Masking parts for high temperature powder coat painting
- Splicing of silicone liners, films and papers
- Use for temporary fixing, attaching or holding





Product	Properties / suitable for	Straight lines and areas masking applications	Sweeping curves masking applications	Powder coating masking applications	Oven-drying systems, IR or heat lamps masking applications	UV-curing & bake cycles masking applications	Automotive masking applications	Temperature resistance (min, h)	Period of use (days)	Indoor and outdoor use	Key Features
 101E	Value masking tape	✓						 60 °C	 1	 	Cost-effective general purpose value masking tape for room temperature indoor light-duty applications.
 201E	General use masking tape	✓						 80 °C	 1	 	General purpose masking tape for short-term paint masking and sealing applications.
 301E	Performance masking tape	✓						 100 °C	 2	 	Performance masking tape for general purpose industrial paint masking applications for air drying and oven curing of paint and lacquer up to a maximum of 100 °C for 1 hour.
 401E	High performance masking tape	✓			✓		✓	 140 °C	 2	 	Provides outstanding quality in all paint applications in the automotive industry and in the industrial market for air-drying and oven-curing of paint up to a maximum of 140 °C for 1 hour.
 501E	Specialty high temperature masking tape	✓			✓	✓	✓	 160 °C	 2	 	Designed for critical paint masking applications for air-drying, oven-curing, infrared or heat lamps, UV-curing and bake cycles masking applications of paint up to a maximum of 160 °C for 1 hour.
 244	Washi masking tape	✓					✓	 100 °C	 30	 	Designed for indoor and outdoor applications where UV resistance, clean removal and sharp paint line is required.
 218	Fine line masking tape	✓	✓				✓	 120 °C	 2	 	Designed to create long straight lines and sweeping curves where a crisp, sharp paint line is desired.
 8901	Performance powder coat painting	✓ 0.06 mm		✓ 0.06 mm				 204 °C	 2	 	Conformable polyester tape ideal for masking in powder coat painting applications and splicing of silicone liners, films and papers.
 8902	Performance powder coat painting	✓ 0.08 mm		✓ 0.08 mm				 204 °C	 2	 	Conformable polyester tape ideal for masking in powder coat painting applications and splicing of silicone liners, films and papers.
 8905	Performance powder coat painting	✓ 0.16 mm		✓ 0.16 mm				 204 °C	 2	 	Conformable polyester tape ideal for masking in powder coat painting applications and splicing of silicone liners, films and papers.
 8991	Masking in extreme environments	✓ 0.06 mm		✓ 0.06 mm				 204 °C	 2	 	General purpose polyester tape with excellent thermal and chemical resistance making it ideal for masking in powder coat painting, anodization, electroplating.
 8992	Masking in extreme environments	✓ 0.08 mm		✓ 0.08 mm				 204 °C	 2	 	General purpose polyester tape with excellent thermal and chemical resistance making it ideal for masking in powder coat painting, anodization, electroplating.
 8995	Masking in extreme environments	✓ 0.06 mm		✓ 0.06 mm				 204 °C	 2	 	General purpose polyester tape with excellent thermal and chemical resistance making it ideal for masking in powder coat painting, anodization, electroplating.

Carton and box sealing

Our carton sealing solutions offer dependable, secure containment and easy application while guaranteeing the best consistency in performance, saving customers time, money and reputations.

Dependable,
secure
containment
and easy
application.

End User benefits







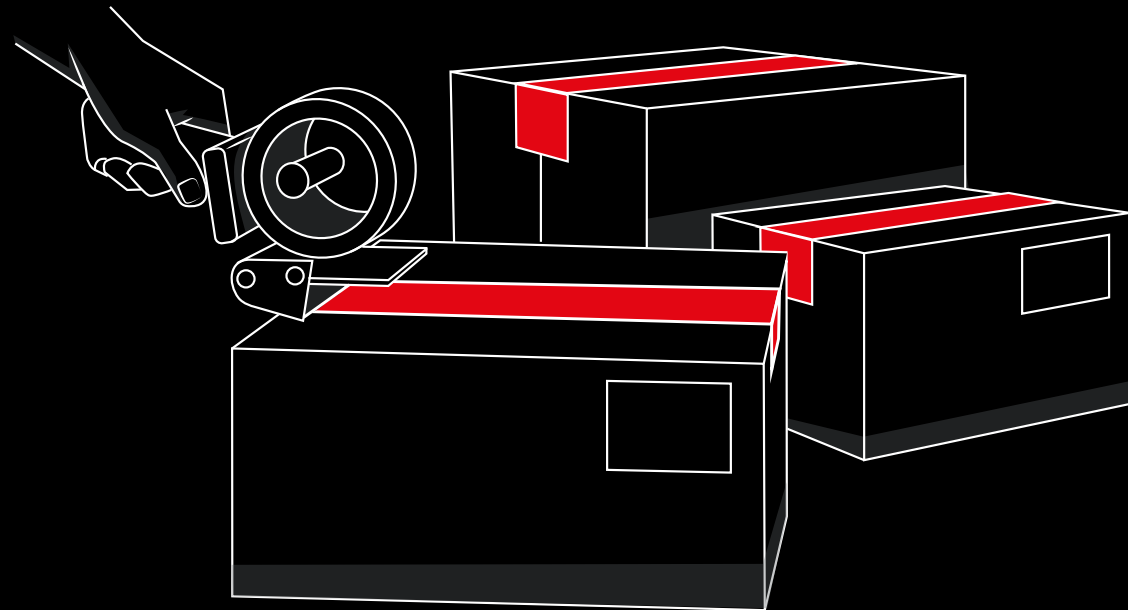



- Delivering quality with tapes that keep production lines moving with less interruption and ensure packages are sealed on arrival
- Once applied the product performs well throughout all temperatures typically encountered by packaged products in shipping and storage environments
- Dependable, secure containment and easy application
- Resists splitting when subjected to rough handling and absorbs impact shock
- Adheres instantly to a variety of surfaces and works especially well on challenging recycled corrugate and fibreboard
- Good performance over a broad range of temperatures, specifically in cold and damp applications
- Reduce noise level in the work area with a slow, low noise unwind

Suggested Applications

- Lightweight box sealing
- Medium- to heavy-weight box sealing
- Single strip closure of fibreboard boxes
- Seal boxes with high recycled content
- Heat shrink sealing and bundling lightweight packages





Product	Properties / suitable for	Light weight packaging	Medium weight packaging	Medium to heavy weight packaging	Low noise	Meets BRC requirements	Adhesive type	Key Features
 309	Low noise and colder & damper						Acrylic	General purpose low noise box sealing tape suitable for lightweight packaging and price sensitive applications.
 313	Low noise						Acrylic	General purpose low noise box sealing tape suitable for light- to medium-weight packaging applications.
 369	Economical general purpose					 *	Hot melt rubber-resin	Cost-effective general purpose box sealing tape designed for use on lightweight envelopes, mailers and non-critical box sealing applications.
 371	Economical general purpose					 *	Hot melt rubber-resin	Cost-effective general purpose box sealing tape designed to securely close a wide variety of lightweight box and carton materials, including corrugated fibreboard.
 6890	Recycled cartons						Solvent natural rubber resin	Low-noise vinyl performance box sealing tape used for single-band sealing of lightweight cardboard boxes and heat shrink sealing.
 3739	Performance tape						Hot melt rubber-resin	Performance box sealing tape to re-seal and package medium- to heavy-weights of valuable goods.
 375E	High performance tape						Hot melt rubber-resin	High performance box sealing tape mainly used for single strip closure of fibreboard boxes, re-sealing and packaging of heavy weight of valuable goods.

* Not all items are certified.

3M Short-length Roll Blister Pack Program

Best sellers for bonding, fastening and sealing solutions

You have a job to do. You want the best products to help you do it right. 3M offers the simple solutions to help your work run smoothly:

Whether it's a bonding, fastening or sealing solution you're looking for, with the "short-length roll blister pack everyday essentials program" you can complete everyday jobs quickly and reliably.

- Always convenient – fits in your toolbox
- Always clean – comes in a dirt-protecting blister pack
- Always practical – bonding, fastening and sealing go faster when you've got the right products for the job



3M™ VHB™ High-Strength Bonding Tapes



3M™ VHB™ Tape 4910

Designed to create durable and reliable bonds of transparent materials or wherever a clear bond is needed.

	Width	Length	Thickness	Colour
3M™ VHB™ Tape 4910	19 mm	11 m	1.0 mm	Clear
3M™ VHB™ Tape 5952	19 mm	11 m	1.1 mm	Black
3M™ VHB™ Tape 5962	19 mm	8 m	1.6 mm	Black
3M™ VHB™ Tape 4991	19 mm	5.5 m	2.3 mm	Grey
3M™ VHB™ Tapes GPH-110GF	19 mm	11 m	1.1 mm	Grey
3M™ VHB™ LSE-110WF	19 mm	11 m	1.1 mm	White

3M™ VHB™ Tape 5952

Designed for permanent bonding to powder coated and rigid irregular surfaces. Offers good adhesion to the widest variety of surfaces, including further high and medium surface energy plastics and paints, metals and glass.

3M™ VHB™ Tape 5962

Thicker version of 3M™ VHB™ Tape 5952.

3M™ VHB™ Tape 4991

Designed for permanent bonding with a high bond strength in critical applications on high to medium surface energy materials. Offering plasticiser resistance.

3M™ VHB™ Tapes GPH-110GF

Designed to create durable and reliable bonds for high temperatures and multi material bonding.

3M™ VHB™ LSE-110WF

Permanent bond designed for bonding LSE plastics such as PP, TPO, TPE, and composite materials without primer.

3M™ High Performance Double Coated Tape



3M™ High Performance Double Coated Tape GPT-020

Excellent initial tack for enhanced performance as well as high adhesion to a wide range of surfaces.

	Width	Length	Thickness	Colour
3M™ High Performance Double Coated Tape GPT-020	19 mm	50 m	0.2 mm	Clear

3M™ Reclosable Fastening Solutions



3M™ Dual Lock™ Reclosable Fastener SJ3555CFB
Bonds to a variety of substrates including metals and plastics such as acrylics, polycarbonate and ABS. Indoor and outdoor use.

Width

25 mm

Length

2.5 m

Thickness

5.7 mm

Colour

Black

3M™ Dual Lock™ Reclosable Fastener SJ356B
Designed to give a translucent appearance that bonds to a variety of substrates including metals, glass and plastics such as acrylics, polycarbonate and ABS. Indoor and outdoor use.

25 mm

2.5 m

5.7 mm

Translucent

3M™ Dual Lock™ Reclosable Fastener SJ354B
Designed for use for plastics (acrylic, polycarbonate and ABS), powder-coated paints and low-surface energy materials (polypropylene and polyethylene). Indoor use.

25 mm

2.5 m

5.7 mm

Black

3M™ Dual Lock™ Reclosable Fastener SJ387B
Strong, reliable and simple to use reclosable fastener for replacing screws, nails, snaps and rivets. Bonds to a variety of substrates including metals, powder-coated paints and plastics such as acrylics, polycarbonate and ABS. Indoor and outdoor use.

25 mm

2.5 m

6.1 mm

Black

3M™ Hook and Loop Fastener SJ352Bbk (Black)
Alternative to a wide variety of reclosable attachment methods, including zips, screws, snaps, hooks and more.

25 mm

1.25 m /
each

3.6 mm

Black

3M™ Hook & Loop Fastener SJ352Bwk (White)
Alternative to a wide variety of reclosable attachment methods, including zips, screws, snaps, hooks and more.

25 mm

1.25 m /
each

3.6 mm

White

3M™ Extreme Sealing Tapes



3M™ Extreme Sealing Tape 4411N (Translucent)
Professional seal over an existing joint or seam which can be exposed to direct sunlight, as well as temperature and humidity extremes.

Width

50 mm

Length

5.5 m

Thickness

1.0 mm

Colour

Translucent

3M™ Extreme Sealing Tape 4411B (Black)
Professional seal over an existing joint or seam which can be exposed to direct sunlight, as well as temperature and humidity extremes.

50 mm

5.5 m

1.0 mm

Black

Product Use

All statements, technical information, and recommendations contained in this document are based upon tests or experience that 3M believes are reliable and are average values not to be used for specification purposes. However, many factors beyond 3M's control can affect the use and performance of a 3M product in a particular application, including the conditions under which the product is used and the time and environmental conditions in which the product is expected to perform. Since these factors are uniquely within the user's knowledge and control, it is essential that the user evaluates the 3M product to determine whether it is fit for a particular purpose and suitable for the user's method or application. All questions of liability relating to this product are governed by the terms of the sale subject, where applicable, to the prevailing law.

Available from:

The RUBIX logo consists of the word "RUBIX" in a bold, blue, sans-serif font, centered within a bright yellow rectangular background.

RUBIX IRELAND

IDA Poppintree Industrial Estate

Finglas

Dublin 11

D11 PW14

Tel: +353 (0)1 830 5455

Web: ie.rubix.com/rgr

The 3M logo is the word "3M" in a bold, red, sans-serif font.